

1. Features

- n -30V/-5.3A, $R_{DS(on)} = 54m\Omega$ (typ)($V_{GS} = -10V$)
 $R_{DS(on)} = 84m\Omega$ ($V_{GS} = -4.5V$)
- n Low gate charge (6nC typical)
- n High power and current handling capability
- n Fast switching speed

2. Applications

This Dual P-Channel MOSFET is a rugged gate version of KIA 's advanced PowerTrench process. It has been optimized for power management applications requiring a wide range of gate drive voltage ratings (4.5V – 20V).

3. Symbol

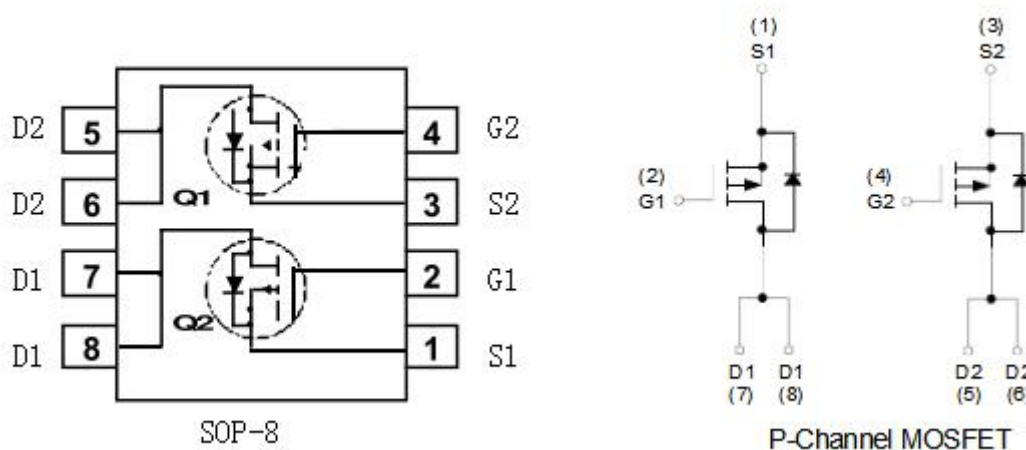

4. Absolute maximum ratings

Parameter	Symbol	Rating	Units
Drain-source voltage	V_{DSS}	-30	V
Gate-source voltage	V_{GS}	± 20	V
Maximum drain current - continuous	I_D	-5.3	A
Maximum drain current- pulsed	I_{DM}	-20	
Maximum power dissipation (note 1)	P_D	$T_C = 25^\circ C$	2
		$T_A = 100^\circ C$	1
Junction and storage temperature range	T_J, T_{STG}	-55 to 150	$^\circ C$
Thermal resistance-junction to ambient (note 1)	$R_{\theta JA}$	78	$^\circ C/W$
Thermal resistance-junction to Case (note 1)	$R_{\theta JC}$	40	$^\circ C/W$

5. Electrical characteristics

(T_J=25°C, unless otherwise noted)

Parameter	Symbol	Test Conditions	Min	Typ	Max	Units
Static						
Drain-source breakdown voltage	BV _{DSS}	V _{GS} =0V, I _D =250μA	-30	-	-	V
Zero gate voltage drain current	I _{DSS}	V _{DS} =24V, V _{GS} =0V	-	-	-1	μA
Gate-source forward leakage	I _{GSS}	V _{GS} =±20V, V _{DS} =0V	-	-	±100	nA
Gate threshold voltage	V _{GS(th)}	V _{DS} = V _{GS} , I _D =250uA	-1.0	-1.7	-3.0	V
Drain-source on-state resistance ²	R _{DS(on)}	V _{GS} =-10V, I _D =-5.3A	-	54	59	mΩ
		V _{GS} =-4.5V, I _D =-4.2A	-	84	89	
Diode forward voltage ²	V _{SD}	V _{GS} =0V, I _S =-3A	-	-0.8	-1.28	V
Dynamic¹						
Total gate charge(4.5V)	Q _g	V _{DS} =-15V, V _{GS} =-5V I _D =-5A	-	6.0	-	nC
Gate-source charge	Q _{gs}		-	2.2	-	
Gate-drain charge	Q _{gd}		-	2.0	-	
Turn-on delay time	t _{d(on)}	V _{DD} =-15V, R _{GEN} =6Ω V _{GS} =-10V, I _D =-1A	-	7	-	ns
Rise time	t _r		-	13	-	
Turn-off delay time	t _{d(off)}		-	14	-	
Fall time	t _f		-	9	-	
Input capacitance	C _{iss}	V _{GS} =0V, V _{DS} =-15V f=1MHz	-	525	-	pF
Output capacitance	C _{oss}		-	130	-	
Reverse transfer capacitance	C _{rss}		-	70	-	

Notes:

1. Guaranteed by design, not subject to production testing

2. Pulse test ; pulse width ≤300μs, duty cycle ≤ 2%

3. R_{θJA} is the sum of the junction-to-case and case-to-ambient thermal resistance where the case thermal reference is defined as the solder mounting surface of the drain pins. R_{θJC} is guaranteed by design while R_{θJC} is determined by the user's board design.

6. Typical operating characteristics

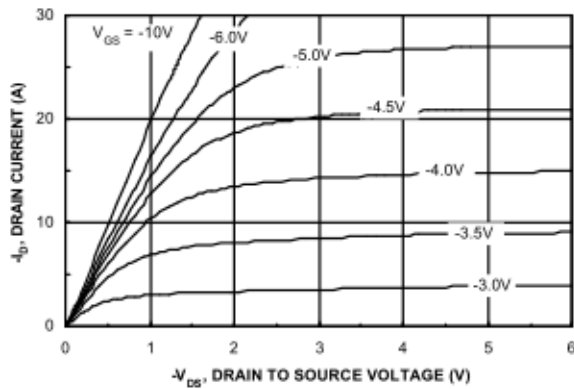

Figure 1. On-Region Characteristics.

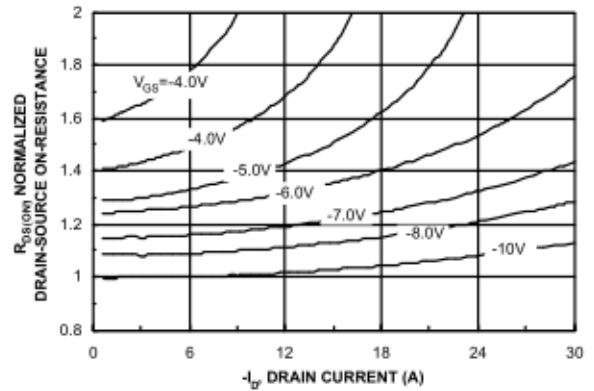

Figure 2. On-Resistance Variation with Drain Current and Gate Voltage.

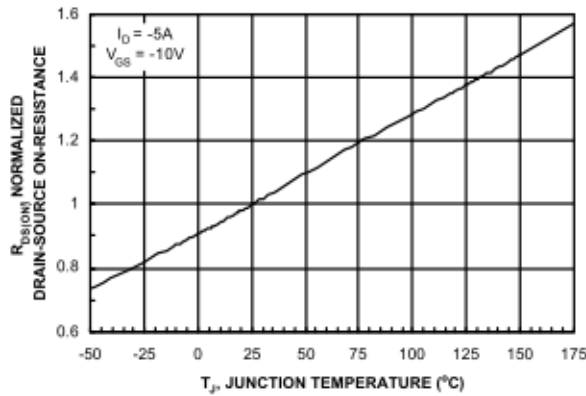

Figure 3. On-Resistance Variation with Temperature.

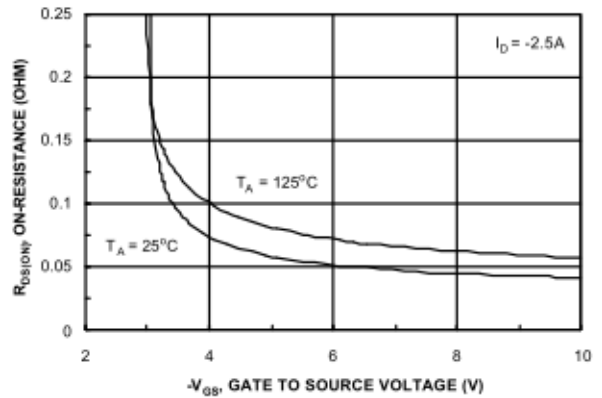

Figure 4. On-Resistance Variation with Gate-to-Source Voltage.

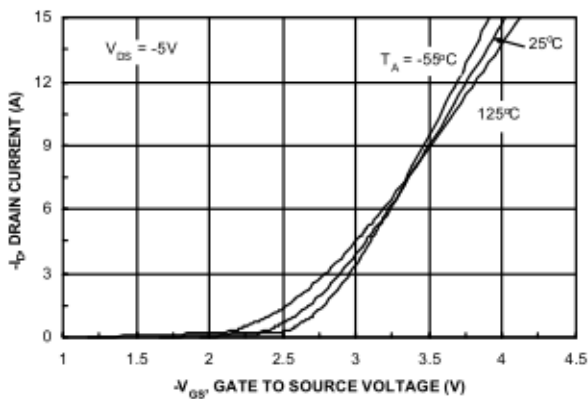

Figure 5. Transfer Characteristics.

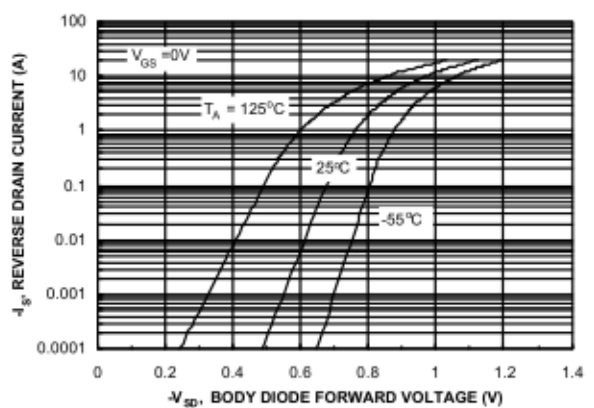

Figure 6. Body Diode Forward Voltage Variation with Source Current and Temperature.

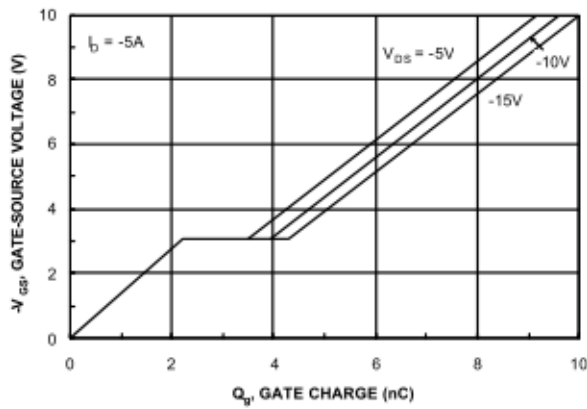

Figure 7. Gate Charge Characteristics.

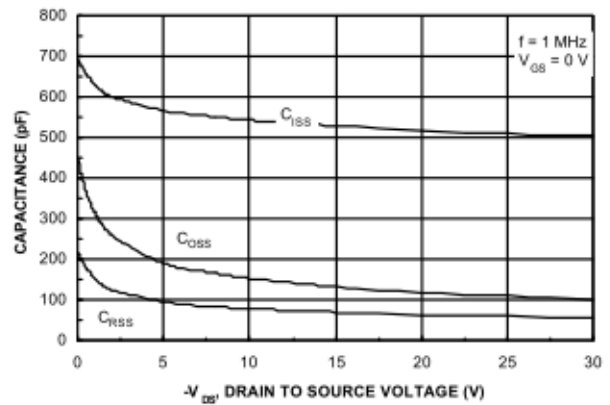

Figure 8. Capacitance Characteristics.

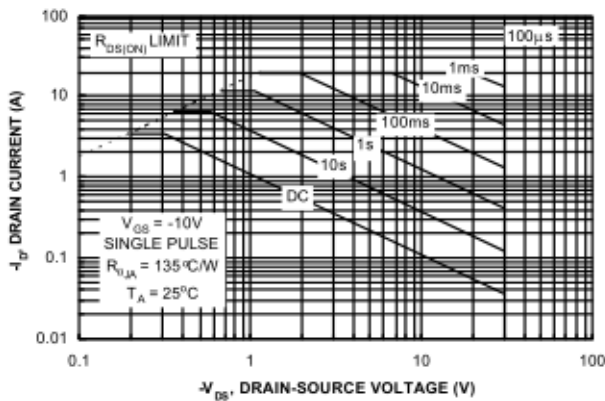

Figure 9. Maximum Safe Operating Area.

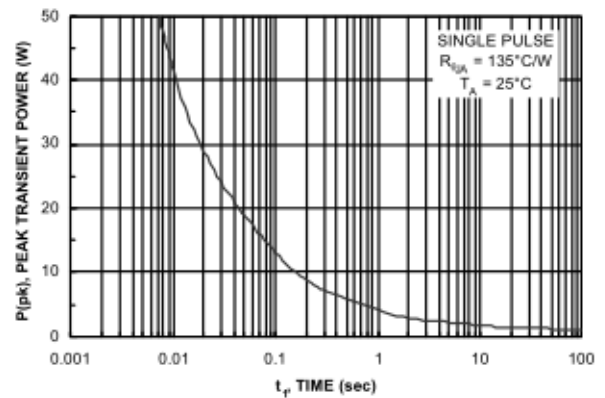

Figure 10. Single Pulse Maximum Power Dissipation.

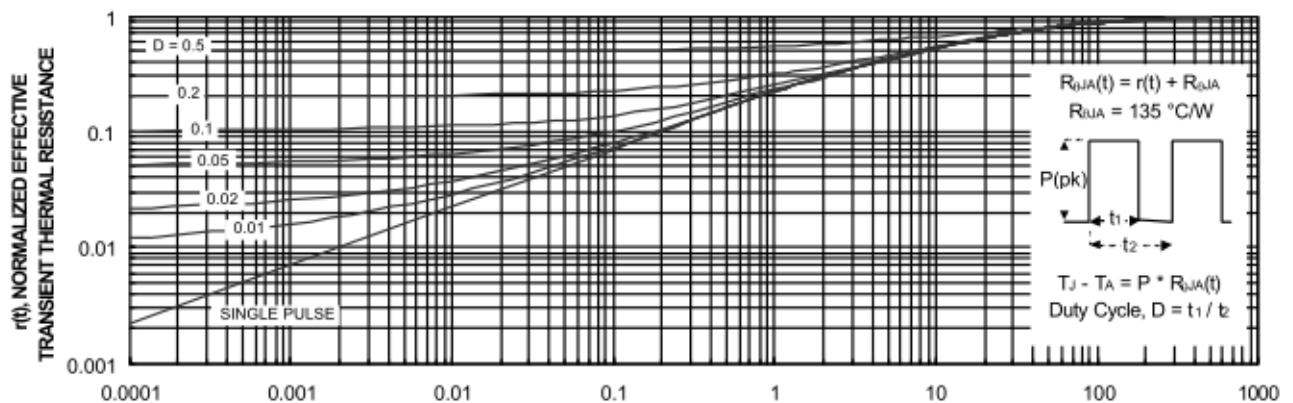

Figure 11. Transient Thermal Response Curve.