

1.Features

- n Advanced trench process technology
- n High density cell design for ultra low on-resistance
- n Fully characterized avalanche voltage and current

2.Applications

- n $V_{ds}=30V$
- n $R_{DS(ON)}=9.0m\Omega(\text{typ.}), V_{GS}@10V, I_{ds}@12A$
- n $R_{DS(ON)}=11.5m\Omega(\text{typ.}), V_{GS}@4.5V, I_{ds}@6A$

3. Pin configuration

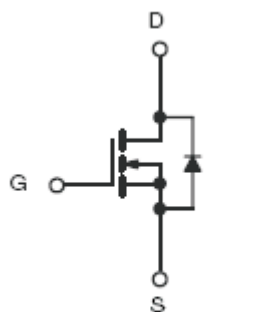
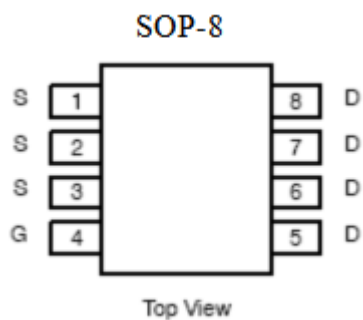

N-Channel MOSFET

| Pin | Function |
|---------|----------|
| 1,2,3 | Source |
| 4 | Gate |
| 5,6,7,8 | Drain |

4. Maximum ratings and thermal characteristics

($T_A=25^\circ\text{C}$, unless otherwise notes)

| Rating | Symbol | Value | Unit | |
|--|------------------------|------------|--------------------|---|
| Drain-source voltage | V_{DS} | 30 | V | |
| Gate-source voltage | V_{GS} | ± 20 | V | |
| Continuous drain current | I_D | 12 | A | |
| Pulsed drain current ¹⁾ | I_{DM} | 48 | A | |
| Maximum power dissipation | $T_A=25^\circ\text{C}$ | P_D | 3.1 | W |
| | $T_A=75^\circ\text{C}$ | P_D | 2.0 | W |
| Operating junction and storage temperature range | T_J/T_{STG} | -55 to 150 | $^\circ\text{C}$ | |
| Junction-to-case thermal resistance | $R_{\theta JC}$ | 40.3 | $^\circ\text{C/W}$ | |
| Junction-to ambient thermal resistance (PCB mount) ²⁾ | $R_{\theta JA}$ | 59 | $^\circ\text{C/W}$ | |

Note: Repetitive rating: pulse width limited by the maximum junction temperature

5. Ordering information

| Part number | Package |
|-------------|---------|
| KNE6306A | SOP-8 |

6. Typical application circuit

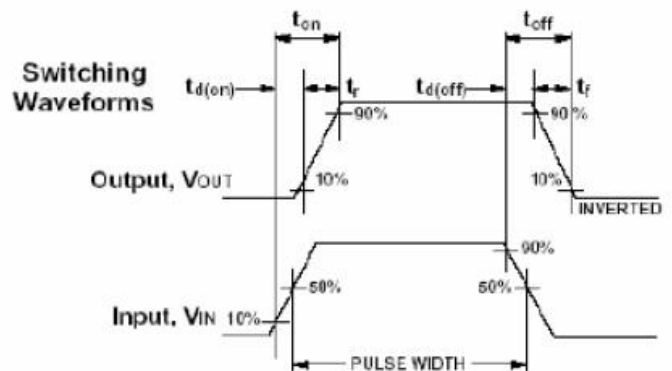
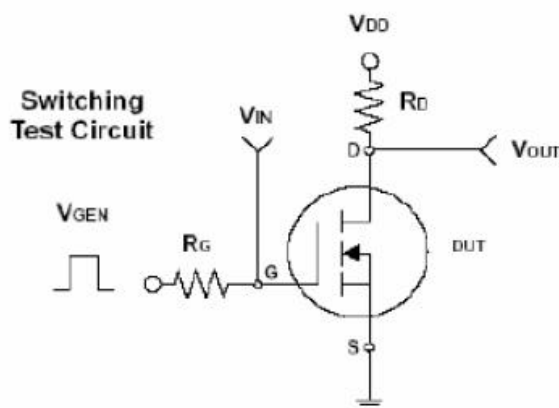

7. Electrical characteristics

(Ta=25°C, unless otherwise notes)

| Parameter | Symbol | Test conditions | Min. | Typ. | Max. | Units |
|----------------------------------|--------------|--|------|------|------|-------|
| Static | | | | | | |
| Drain-source breakdown voltage | BV_{DSS} | $V_{GS}=0V, I_D=250\mu A$ | 30 | - | - | V |
| Drain-source on-state resistance | $R_{DS(ON)}$ | $V_{GS}=4.5V, I_D=6A$ | - | 11.5 | 14.0 | mΩ |
| | | $V_{GS}=10V, I_D=12A$ | - | 8.0 | 10.0 | mΩ |
| Gate threshold voltage | $V_{GS(th)}$ | $V_{DS}=V_{GS}, I_D=-250\mu A$ | 1 | 1.8 | 3 | V |
| Forward transconductance | G_{fs} | $V_{DS}=15V, I_D=6A$ | - | 12 | - | S |
| Zero gate voltage drain current | I_{DSS} | $V_{DS}=25V, V_{GS}=0V$ | - | - | 1 | μA |
| Gate-source forward leakage | I_{GSS} | $V_{GS}=\pm 20V, V_{DS}=0V$ | - | - | ±100 | nA |
| Dynamic³⁾ | | | | | | |
| Total gate charge | Q_g | $I_D=35A$ $V_{DS}=15V$ $V_{GS}=10V$ | - | 10 | - | nC |
| Gate-source charge | Q_{gs} | | - | 3.5 | - | nC |
| Gate-drain ("miller") charge | Q_{gd} | | - | 3 | - | nC |
| Turn-on delay time | $t_{d(off)}$ | $V_{DD}=15V$ $I_D=1A$ $R_G=6\Omega$ $R_L=15\Omega$ $V_{GEN}=10V$ | - | 12 | - | ns |
| Rise time | t_r | | - | 4 | - | ns |
| Turn-off delay time | $t_{d(off)}$ | | - | 32 | - | ns |
| Fall time | t_f | | - | 6 | - | ns |
| Input capacitance | C_{iss} | $V_{GS}=0V$ $V_{DS}=15V$ $f=1.0MHz$ | - | 1300 | - | pF |
| Output capacitance | C_{oss} | | - | 270 | - | pF |
| Reverse transfer capacitance | C_{rss} | | - | 145 | - | pF |

Source-drain diode

| Parameter | Symbol | Test condition | Min. | Typ. | Max. | Units |
|----------------------------|----------|----------------------|------|------|------|-------|
| Diode forward voltage | V_{SD} | $I_S=10A, V_{GS}=0V$ | - | 0.87 | 1.5 | V |
| Max. diode forward current | I_S | | - | - | 12 | A |

Notes: Pulse width $\leq 300\mu s$, duty cycle $\leq 2\%$

8. Test circuits and waveforms

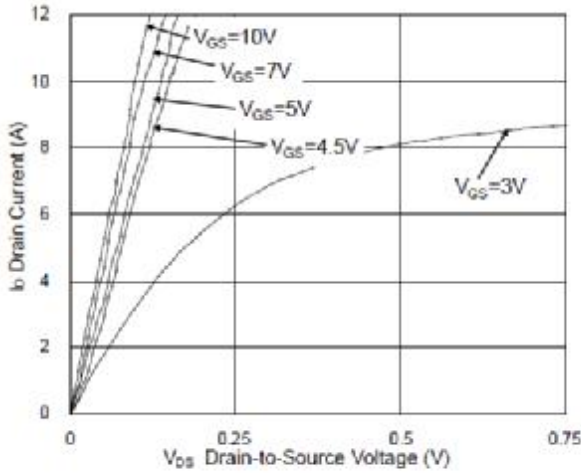

Fig.1 Typical Output Characteristics

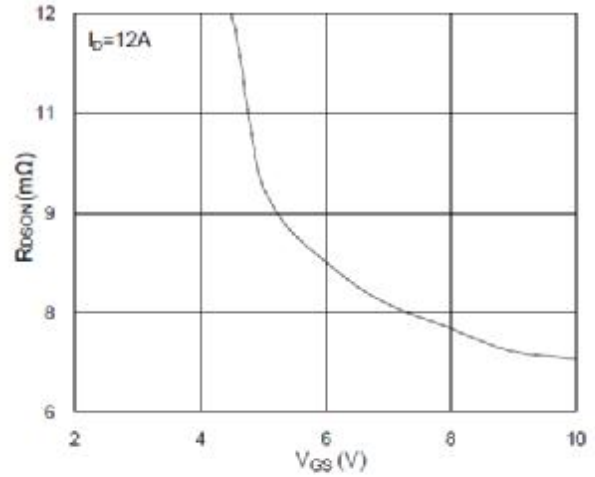

Fig.2 On-Resistance vs. G-S Voltage

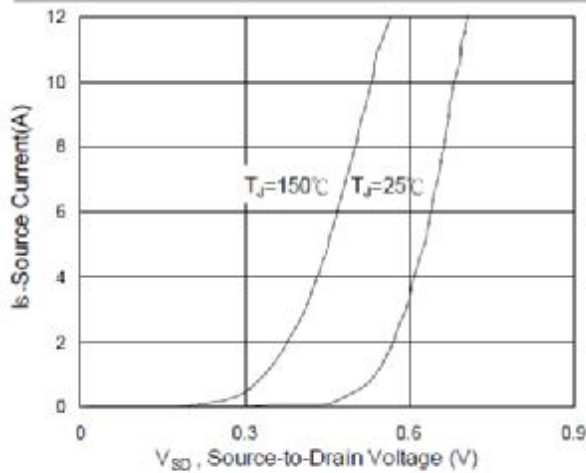

Fig.3 Forward Characteristics of Reverse

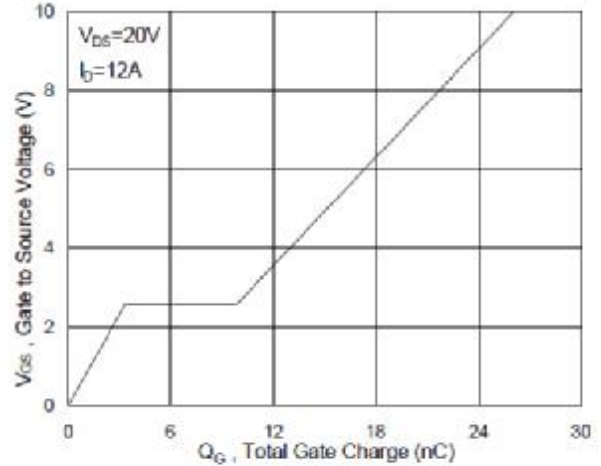

Fig.4 Gate-Charge Characteristics

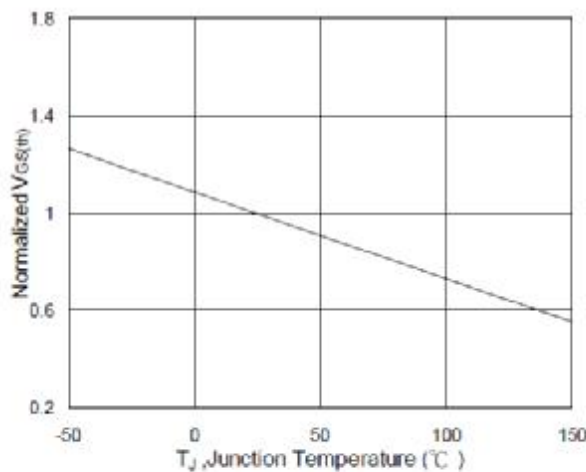

Fig.5 Normalized $V_{GS(th)}$ vs. T_J

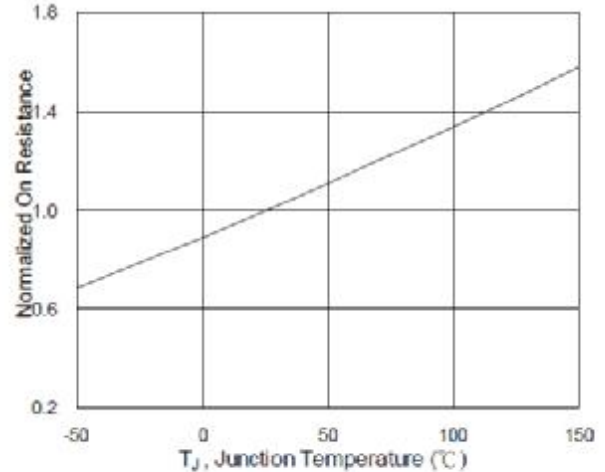

Fig.6 Normalized $R_{DS(on)}$ vs. T_J

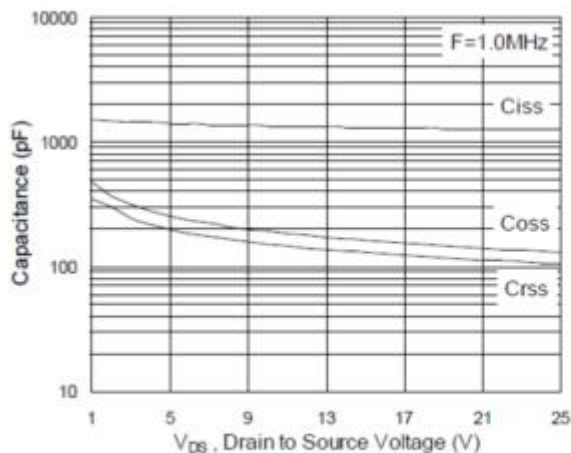

Fig.7 Capacitance

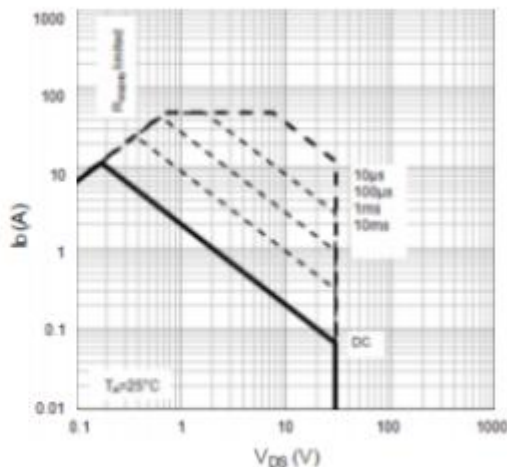

Fig.8 Safe Operating Area

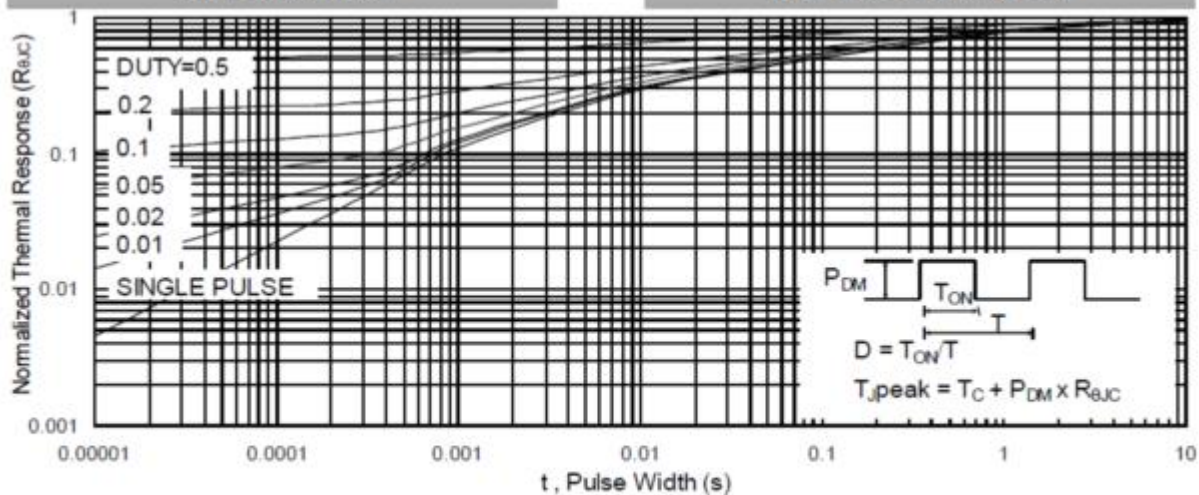

Fig.9 Normalized Maximum Transient Thermal Impedance

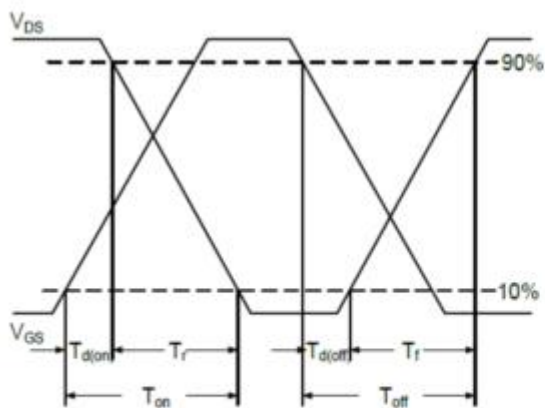

Fig.10 Switching Time Waveform

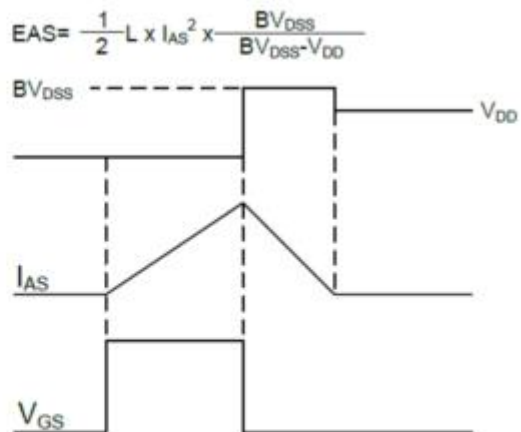

Fig.11 Unclamped Inductive Switching Waveform